





# TABLE OF CONTENTS

<b>F&amp;P Neopuff™ Infant T-Piece Resuscitator</b> .....	2
Stand Alone .....	2
Infant Warmer Integrated Module .....	4
<b>Infant Resuscitation T-Piece Circuits</b> .....	6
Single Use T-Piece Circuit - Classic .....	6
Single Use T-Piece Circuit - Ergonomic .....	6
Single Use T-Piece Circuit - Humidified.....	6
<b>Infant Resuscitation Masks and Kits</b> .....	7
Single Use Infant Resuscitation Masks.....	7
Single Use Resuscitation Kits.....	7
<b>Accessories</b> .....	9
Reusable Test Lung .....	9
Reusable Gas Supply Line .....	9
Gas Inlet Adaptor .....	9
Accessory Hook .....	9
Poles .....	10
Gas Blenders.....	11
Humidifier .....	11
Gas Hoses.....	12
<b>Mounting Options</b> .....	14
Pole Mount .....	14
Wall Mount.....	14
Pole and Rail Central Mount.....	15
Ohmeda Assembly Kit .....	15
<b>Sample Setup</b> .....	16
<b>Part Number Index</b> .....	17

# F&P NEOPUFF™ INFANT T-PIECE RESUSCITATOR

## F&P Neopuff™ Infant T-Piece Resuscitator (Stand Alone)

The F&P Neopuff™ Infant T-Piece Resuscitator is a lightweight, stand alone resuscitator unit suitable for Labor and Delivery Units, Postnatal Wards, Operating Rooms, Transport, Special Care Baby Units and Neonatal Intensive Care Units. Current resuscitation guidelines recommend the use of a T-Piece device with the potential benefits of achieving controlled target Peak Inspiratory Pressure (PIP) and delivering consistent Positive End Expiratory Pressure (PEEP) to help establish Functional Residual Capacity (FRC) and improve lung volume.

Includes: Gas Supply Line (900RD009), Gas Inlet Adaptor (900RD101), Test Lung (RD020-01), Spare Max Pressure Relief Cap, Animated User Guide (CD), Operating Instructions and Product Technical Manual (CD).

### ENGLISH TEXT FRONT LABEL

#### Diagram

#### Product Code & Operating Instruction Language

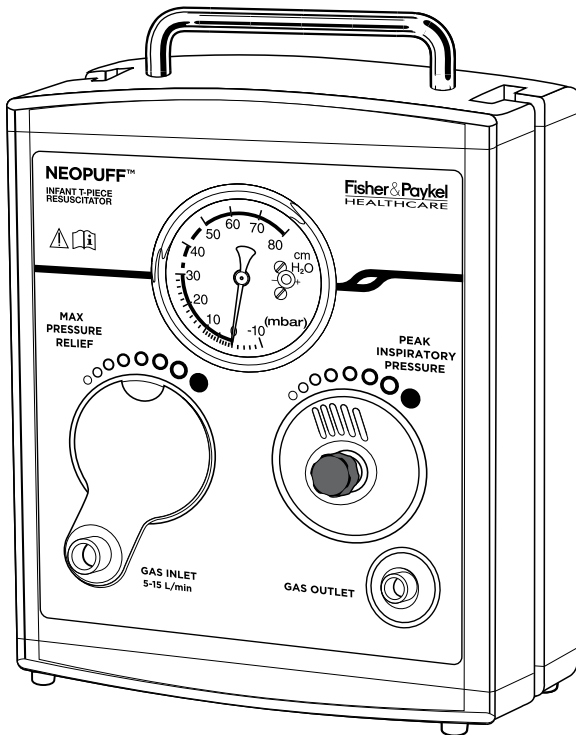

RD900AEU - English

**SYMBOLS FRONT LABEL**

**Diagram**

**Product Code & Operating Instruction Language**

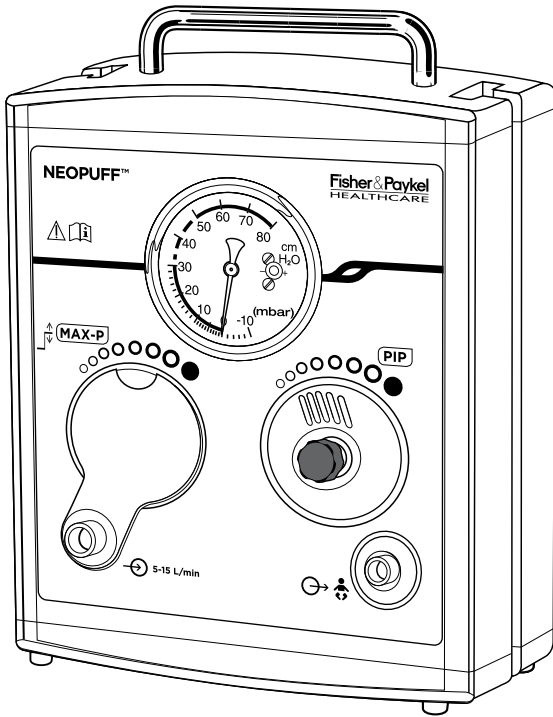

- RD900ADU - Danish
- RD900AFU - French
- RD900ALU - Italian
- RD900AMU - Finnish
- RD900ANU - Dutch
- RD900ASU - Spanish
- RD900ATU - Portuguese
- RD900AVU - Norwegian
- RD900AWU - Swedish
- RD900AZU - Chinese

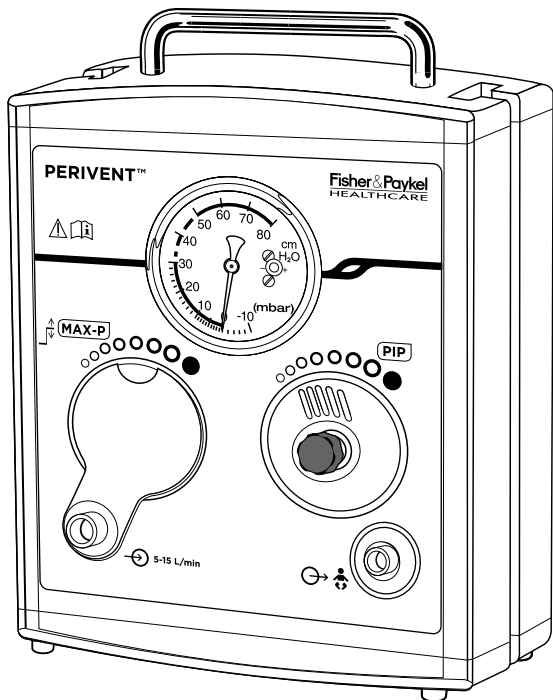

- RD900AGU - German

# F&P NEOPUFF™ INFANT T-PIECE RESUSCITATOR

## F&P Neopuff™ Infant T-Piece Resuscitator (Infant Warmer Integrated Module)

The F&P Neopuff™ Infant T-Piece Resuscitator is also available as an integrated module inserted into the front of the CosyCot™ Infant Warmer. This allows easy access for the operator in resuscitating the patient, especially during transport.

Includes: Gas Supply Line (Long and Short), Gas Inlet Adaptor (900RD101), Test Lung (RD020-01), Spare Max Pressure Relief Cap, Animated User Guide (CD), Operating Instructions (Swing Tag), Installation Guide, Product Technical Manual (CD) and 4x Screws.

### ENGLISH TEXT FRONT LABEL

Diagram

Product Code & Operating Instruction Language

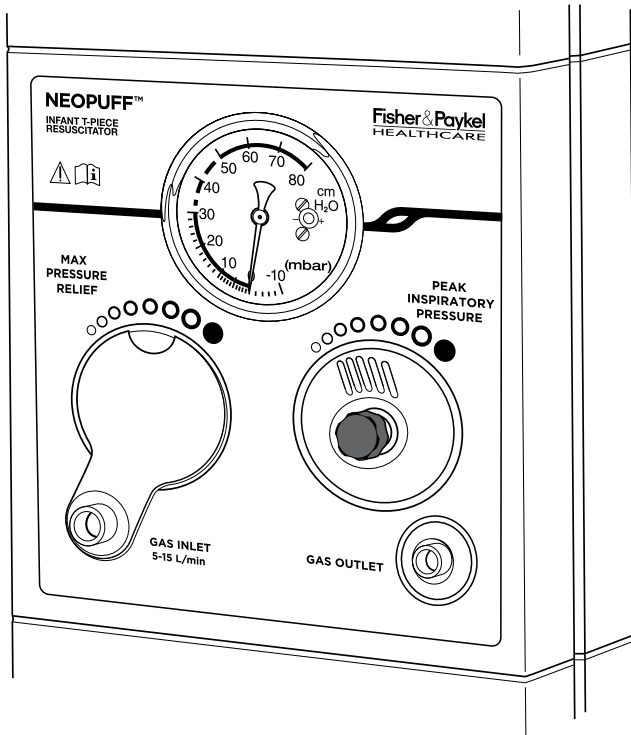

900IW130E - English

**SYMBOLS FRONT LABEL**

**Diagram**

**Product Code & Operating Instruction Language**

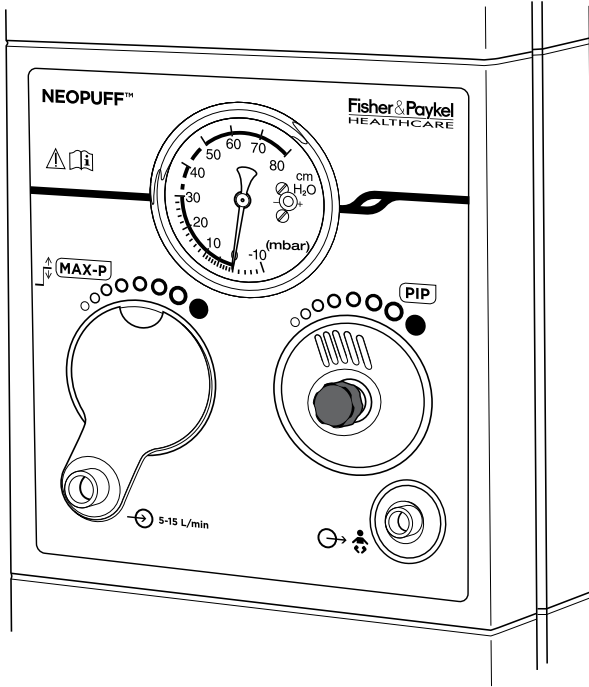

- 900IW130D - Danish
- 900IW130F - French
- 900IW130L - Italian
- 900IW130M - Finnish
- 900IW130N - Dutch
- 900IW130S - Spanish
- 900IW130T - Portuguese
- 900IW130V - Norwegian
- 900IW130W - Swedish
- 900IW130Z - Chinese

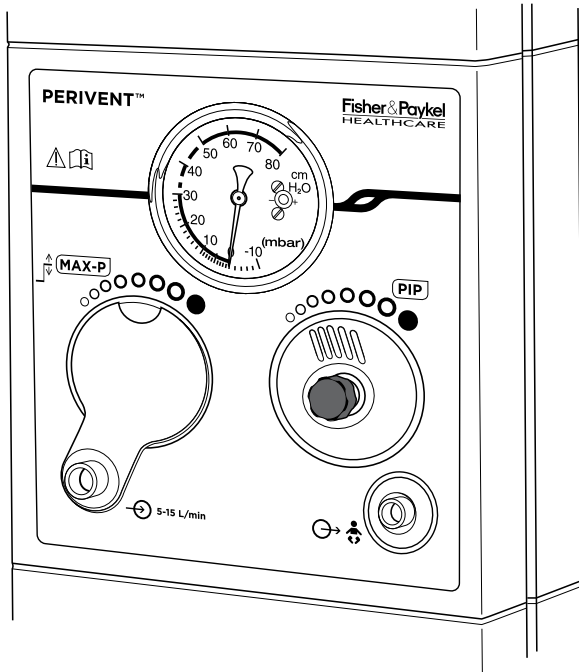

- 900IW130G - German

# INFANT RESUSCITATION T-PIECE CIRCUITS

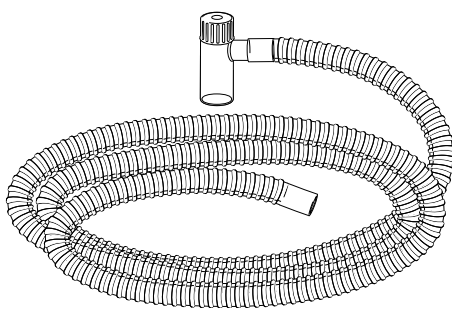

## Single Use T-Piece Circuit – Classic

The T-Piece Circuit includes an adjustable PEEP valve to achieve a desired PEEP level. The tubing is 1.4 m (55”) in length and includes a 10 mm female device connector that has been designed to securely connect to the F&P Neopuff™ Infant T-Piece Resuscitator.

Product Code	Description	
900RD010	Single Use T-Piece Circuit – Classic	10/bx

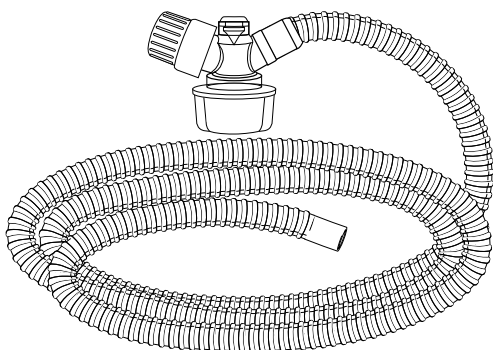

## Single Use T-Piece Circuit – Ergonomic

The T-Piece Circuit features an ergonomically designed PEEP valve to provide a comfortable and controlled hold of the circuit. A duckbill port is also incorporated for appropriate applications, such as suctioning and surfactant delivery.

- The tubing length is 1.6 m (63”)
- Two options for mask and endotracheal tube connection:
  - 15 mm female and 22 mm male
- Includes a cap to allow for setting of pressures

Product Code	Description	
RD1300-10	Single Use T-Piece Circuit – Ergonomic	10/bx
RD1301-10	<ul style="list-style-type: none"> <li>• Single Use T-Piece Circuit – Ergonomic</li> <li>• Gas Supply Line (Long)</li> </ul>	10/bx

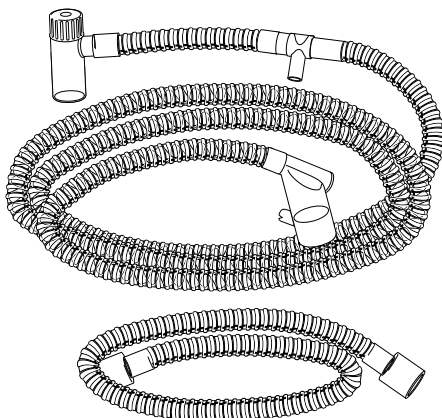

## Single Use T-Piece Circuit – Humidified

The T-Piece Circuit with adjustable PEEP valve is provided with a heated circuit designed to deliver warm, humidified gas to an infant during resuscitation. It is compatible with the Fisher & Paykel Healthcare MR850 Humidifier.



Product Code	Description	
900RD110	Single Use T-Piece Circuit – Humidified	10/bx



# INFANT RESUSCITATION MASKS AND KITS

## Single Use Infant Resuscitation Masks

The Infant Resuscitation Masks are specifically designed to conform comfortably to an infant's face, facilitating a seal for the purposes of resuscitation. The wide range of sizes includes extra-small sizes for premature neonates, to large sizes for pediatric patients.

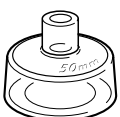
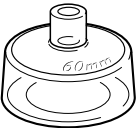
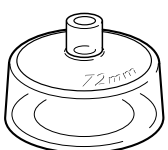
Mask Size	Mask External Diameter
 Micro-Premature (XS) Mask	35 mm (1.38")
 Premature (S) Mask	42 mm (1.65")
 Neonatal (M) Mask	50 mm (1.97")
 Infant (L) Mask	60 mm (2.36")
 Pediatric (XL) Mask	72 mm (2.83")

Product Code	Description	
RD800-EN	Starter Kit – English Text Packaging	5 sizes/bx
RD800-SK	Starter Kit – Universal Packaging	5 sizes/bx
RD803-10	Micro-Premature (XS) Mask	10/bx
RD804-10	Premature (S) Mask	10/bx
RD805-10	Neonatal (M) Mask	10/bx
RD806-10	Infant (L) Mask	10/bx
RD807-10	Pediatric (XL) Mask	10/bx

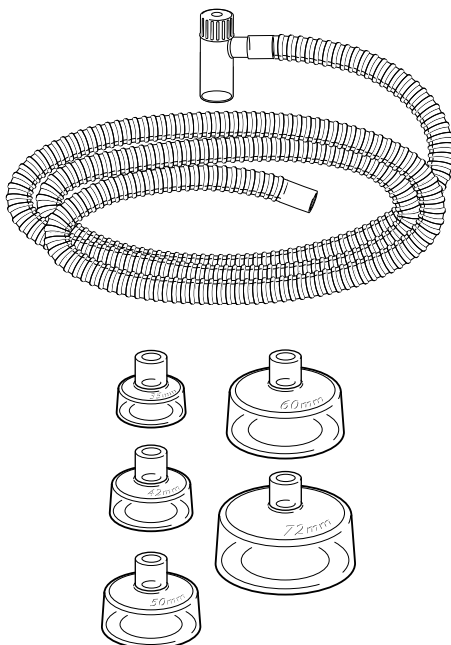

## Single Use Resuscitation Kits

Each T-Piece Resuscitation Kit includes an infant resuscitation mask and a single use T-Piece Circuit – Classic.

Product Code	Description	
900RD014-10	<ul style="list-style-type: none"> <li>Single Use T-Piece Circuit – Classic</li> <li>Premature (S) Mask</li> </ul>	10 kits/bx
900RD015-10	<ul style="list-style-type: none"> <li>Single Use T-Piece Circuit – Classic</li> <li>Neonatal (M) Mask</li> </ul>	10 kits/bx
900RD016-10	<ul style="list-style-type: none"> <li>Single Use T-Piece Circuit – Classic</li> <li>Infant (L) Mask</li> </ul>	10 kits/bx

# RESUSCITATION KITS

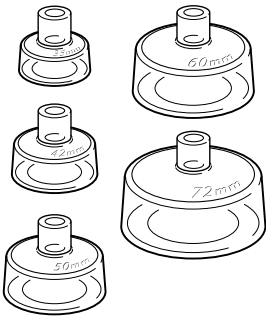
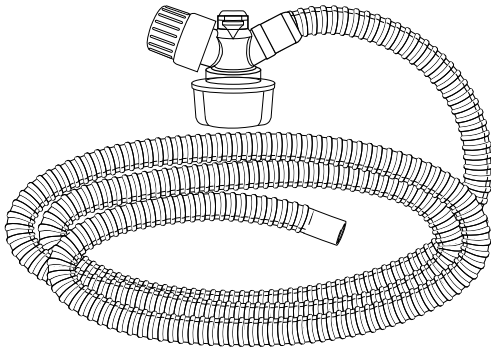

## Single Use Resuscitation Kits

Each T-Piece Resuscitation Kit includes an infant resuscitation mask and a single use T-Piece Circuit – Ergonomic.

Product Code	Description	
RD1330-10	<ul style="list-style-type: none"> <li>Single Use T-Piece Circuit – Ergonomic</li> <li>Micro-Premature (XS) Mask</li> </ul>	10 kits/bx
RD1340-10	<ul style="list-style-type: none"> <li>Single Use T-Piece Circuit – Ergonomic</li> <li>Premature (S) Mask</li> </ul>	10 kits/bx
RD1350-10	<ul style="list-style-type: none"> <li>Single Use T-Piece Circuit – Ergonomic</li> <li>Neonatal (M) Mask</li> </ul>	10 kits/bx
RD1360-10	<ul style="list-style-type: none"> <li>Single Use T-Piece Circuit – Ergonomic</li> <li>Infant (L) Mask</li> </ul>	10 kits/bx
RD1370-10	<ul style="list-style-type: none"> <li>Single Use T-Piece Circuit – Ergonomic</li> <li>Pediatric (XL) Mask</li> </ul>	10 kits/bx

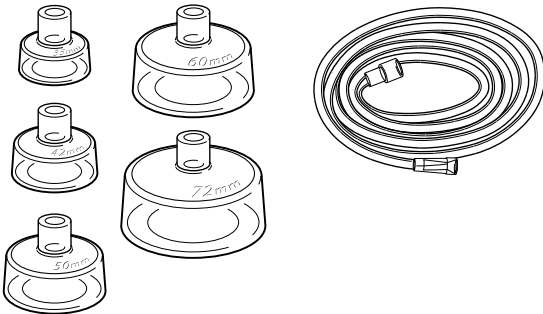
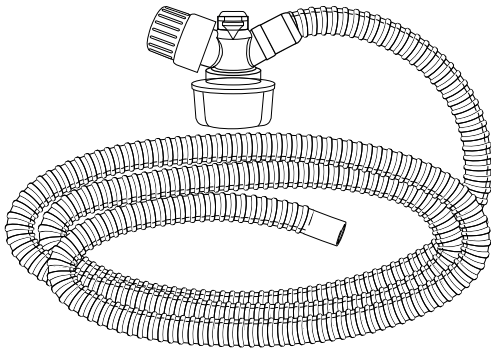

Each T-Piece Resuscitation Kit includes an infant resuscitation mask and a single use adjustable T-Piece Circuit – Ergonomic and Gas Supply Line.

Product Code	Description	
RD1331-10	<ul style="list-style-type: none"> <li>Single Use T-Piece Circuit – Ergonomic</li> <li>Micro-Premature (XS) Mask</li> <li>Gas Supply Line (Long)</li> </ul>	10 kits/bx
RD1341-10	<ul style="list-style-type: none"> <li>Single Use T-Piece Circuit – Ergonomic</li> <li>Premature (S) Mask</li> <li>Gas Supply Line (Long)</li> </ul>	10 kits/bx
RD1351-10	<ul style="list-style-type: none"> <li>Single Use T-Piece Circuit – Ergonomic</li> <li>Neonatal (M) Mask</li> <li>Gas Supply Line (Long)</li> </ul>	10 kits/bx
RD1361-10	<ul style="list-style-type: none"> <li>Single Use T-Piece Circuit – Ergonomic</li> <li>Infant (L) Mask</li> <li>Gas Supply Line (Long)</li> </ul>	10 kits/bx
RD1371-10	<ul style="list-style-type: none"> <li>Single Use T-Piece Circuit – Ergonomic</li> <li>Pediatric (XL) Mask</li> <li>Gas Supply Line (Long)</li> </ul>	10 kits/bx

# ACCESSORIES



## Reusable Test Lung

The Reusable latex free Test Lung is made of silicone and is NOT autoclavable.

Product Code	Description	
RD020-01	Reusable Test Lung	1/bx

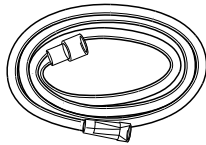

## Reusable Gas Supply Line

- Length 310 mm (12.2”) with 10 mm M gas inlet connection

Product Code	Description	
900RD008	Gas Supply Line (Short)	10/bx

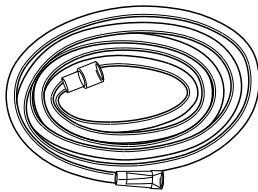

- Length 2.1 m (82.7”) with 10 mm M gas inlet connection

Product Code	Description	
900RD009	Gas Supply Line (Long)	10/bx

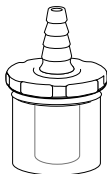

## Gas Inlet Adaptor

The Gas Inlet Adaptor connects oxygen/air tubing to the Gas Inlet Port.

Product Code	Description	
900RD101	Gas Inlet Adaptor	10/bx

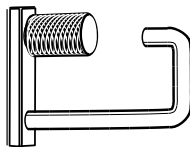

## Accessory Hook

The Accessory Hook provides an adjustable point for convenient and tidy placement of the T-Piece Circuit on standby.

Maximum Loading 5 kg (11 lb)

Product Code	Description	
900IW305	Accessory Hook	1/bx

# ACCESSORIES

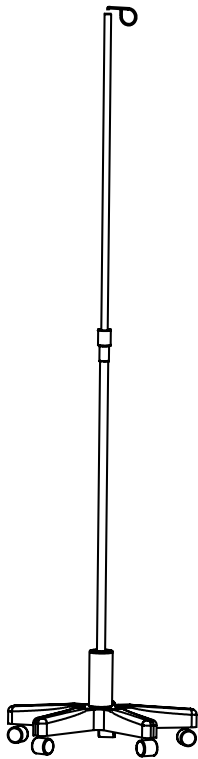

## Telescopic Water Bag Pole

For mounting the F&P Neopuff™ Infant T-Piece Resuscitator and the humidifier to a mobile humidifier stand.

Minimum Height 1.64 m

Maximum Height 2.64 m

Product Code	Description	
900MR292	Humidifier Stand-Telescopic	1/bx

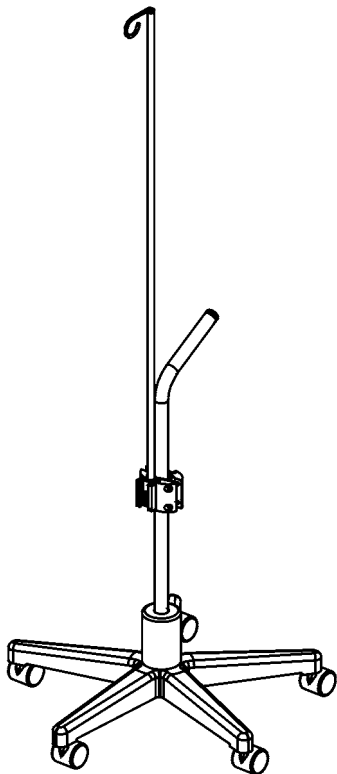

## Humidifier Stand with Water Bag Pole

For mounting the F&P Neopuff™ Infant T-Piece Resuscitator and the humidifier to a mobile humidifier stand.

Maximum Height 1.64 m

Product Code	Description	
900MR293	Humidifier Stand Complete	1/bx

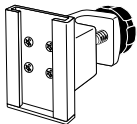
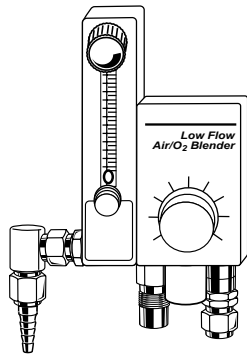

Blender Pole Mount Bracket

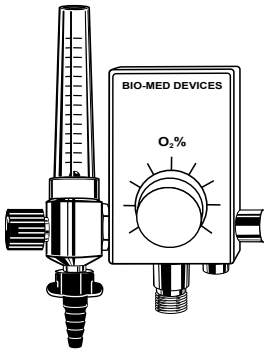

## Gas Blenders

Gas Blenders come complete with color-coded nipples and control knobs.

- Flow rate 2 to 16 L/min (Bird)  
0 to 15 L/min (Bio-Med)
- Includes flow meter nipples (green or white)

NOTE: Requires 900IW320 Bird Bracket Blender Complete to be fitted to the CosyCot™ Infant Warmer. Gas hoses not included. Please refer to Gas Hoses section, page 12.

Product Code	Description
BC501-01	Bird MicroBlender 2 to 16 L/min DISS
BC502-01	Bird MicroBlender 2 to 16 L/min NIST
BC506-01	Blender Oxy/Air Bio-Med (DISS) green
BC507-01	Blender Oxy/Air Bio-Med (DISS) white
BC510-01	Blender Pole Mount Bracket



Humidifier

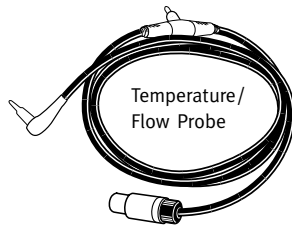

Temperature/  
Flow Probe

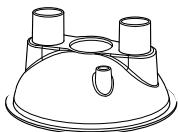

Humidifier Chamber

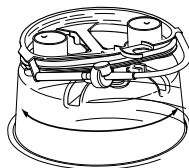

Autofeed Humidifier Chamber

## Humidifier

HUMIDIFICATION	
Product Code	Description
MR850	Humidifier
MR225	Humidifier Chamber*
MR290	Autofeed Humidifier Chamber*
900MR806	Heater-wire Adaptor MR850
900MR868	Temperature/Flow Probe Ang 1100 mm (44")

For additional information on humidification devices and accessories, please refer to the Fisher & Paykel Healthcare Respiratory Humidification Products Catalog or contact your Fisher & Paykel Healthcare representative.

\* In North America the MR850 Humidifiers and MR225/MR290 Chambers must be purchased from CareFusion



Heater-wire  
Adaptor

# ACCESSORIES

## Gas Hoses

Fisher & Paykel Healthcare offers the following range of Gas Hoses. If your exact requirements are not met within this range, please discuss your requirements with your Fisher & Paykel Healthcare representative.

- 3 m (10') Hoses

<b>From</b>	<b>To</b>
Gas Accessory Block	Hospital Pipeline Supply
Gas Low Pressure Module	Hospital Pipeline Supply
Gas Supply Module	Hospital Pipeline Supply

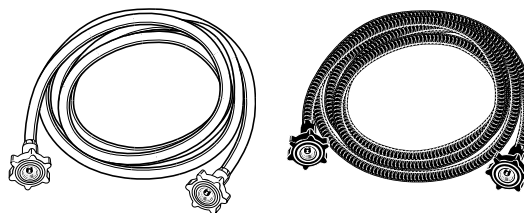

- 550 mm (2') Hoses

<b>From</b>	<b>To</b>
Gas Accessory Block	Gas Supply Module
Gas Accessory Block	Cylinder Regulator
Gas Low Pressure Module	Cylinder Regulator

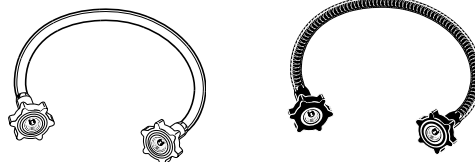

OXYGEN				
Manifold Hose Fitting	Wall/Cylinder Hose Fitting	Hose Length	Hose Color	Part Number
DISS	DISS	550 mm (2')	Green	HS-02UO-DHDFC4
DISS	DISS	3 m (10')	Green	HS-10UO-DHDFC4
DISS	OHMEDA	3 m (10')	Green	HS-10UO-DFOMC4
DISS	PURITAN	3 m (10')	Green	HS-10UO-DFPMC4
DISS	CHEMETRON	3 m (10')	Green	HS-10UO-DFCMC4
DISS	SCHRADER	3 m (10')	Green	HS-10UO-DFBMC4
DISS	DISS	550 mm (2')	White	HS-02IO-DHDFC4
DISS	DISS	3 m (10')	White	HS-10IO-DHDFC4
NIST	BS PROBE	3 m (10')	White	HS-10IO-NFBMC4
NIST	BS PROBE	550 mm (2')	White	HS-02IO-NFBMC4
AUST	AUST	3 m (10')	White	043041042
AUST	AUST	550 mm (2')	White	043041043
AFNOR	AFNOR	3 m (10')	White	043042374
DISS	BS PROBE	3 m (10')	White	HS-10IO-DFBMC4

AIR				
Manifold Hose Fitting	Wall/Cylinder Hose Fitting	Hose Length	Hose Color	Part Number
DISS	DISS	550 mm (2')	Yellow	HS-02UA-DHDFC4
DISS	DISS	3 m (10')	Yellow	HS-10UA-DHDFC4
DISS	OHMEDA	3 m (10')	Yellow	HS-10UA-DFOMC4
DISS	PURITAN	3 m (10')	Yellow	HS-10UA-DFPMC4
DISS	CHEMETRON	3 m (10')	Yellow	HS-10UA-DFCMC4
DISS	SCHRADER	3 m (10')	Yellow	HS-10UA-DFSMC4
DISS	DISS	550 mm (2')	Black	HS-02IA-DHDFC4
DISS	DISS	3 m (10')	Black	HS-10IA-DHDFC4
NIST	BS PROBE	3 m (10')	Black	HS-10IA-NFBMC4
NIST	BS PROBE	550 mm (2')	Black	HS-02IA-NFBMC4
AUST	AUST	3 m (10')	Black	043041044
AUST	AUST	550 mm (2')	Black	043041045
AFNOR	AFNOR	3 m (10')	Black	043042375
DISS	BS PROBE	3 m (10')	Black	HS-10-IA-DFBMC4

**Color Code:**

U : USA  
I : ISO

Length in feet

HS-XYZ-XYZXX

**Hose Type:**

C4 : Conductive 1/4"  
C5 : Conductive 5/16"

**Gas Type:**

O : Oxygen  
A : Medical Air  
V : Medical Vacuum

**Inlet & Outlet Connections:**

DF : DISS Hex Nut  
DH : DISS Handtight  
NF : NIST Hex Nut  
BM : BS PROBE Male  
OM : Ohmeda Male  
PM : Puritan Male  
CM : Chemetron Male  
SM : Schrader Male



# MOUNTING OPTIONS

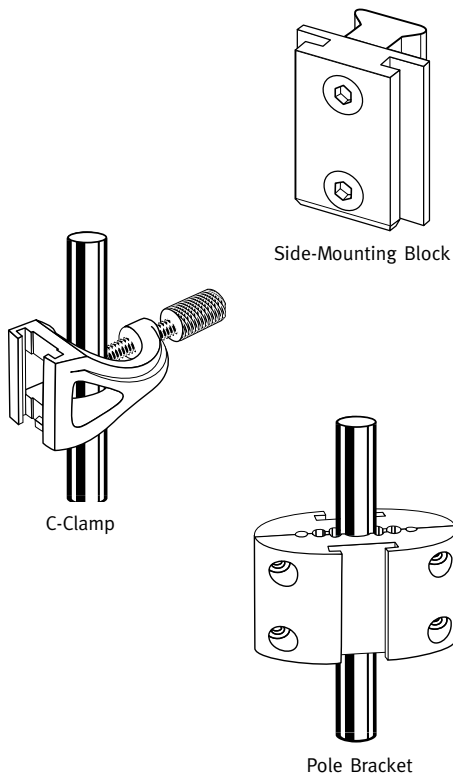

The F&P Neopuff™ Infant T-Piece Resuscitator can be mounted on a pole using a Side-Mounting Block and a C-Clamp or a Pole Bracket.

Product Code	Description
900RD301	Side-Mounting Block
900MR170	C-Clamp
900MR030	Pole Bracket

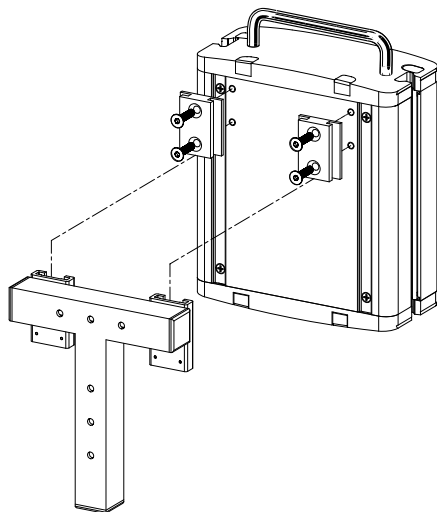
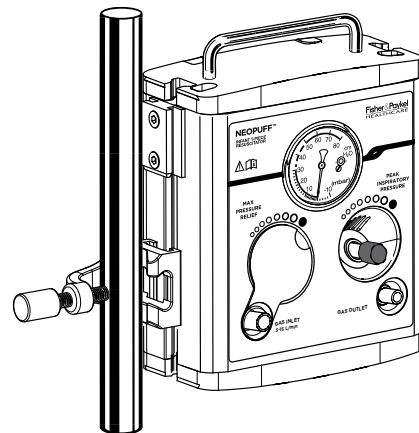

## Wall Mount

The F&P Neopuff™ Infant T-Piece Resuscitator can be mounted on the wall using two mounting tongues and a Wall Mount Bracket.

Product Code	Description
900RD302	Wall Mount Bracket (with 2 mounting tongues)

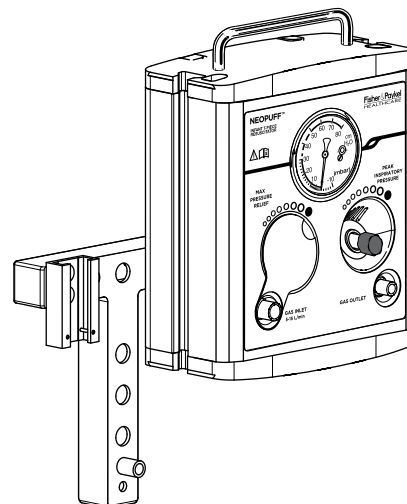



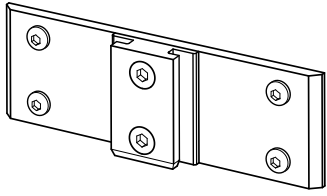

## Pole and Rail Central Mount

The F&P Neopuff™ Infant T-Piece Resuscitator can be centrally mounted on a pole or on standard rails (2.5 to 5.5 cm x 1 cm / 0.98 to 2.17" x 0.39"), using a Central Mounting Block affixed to the back of the unit, and fitted to Fisher & Paykel Healthcare bracket and clamps.

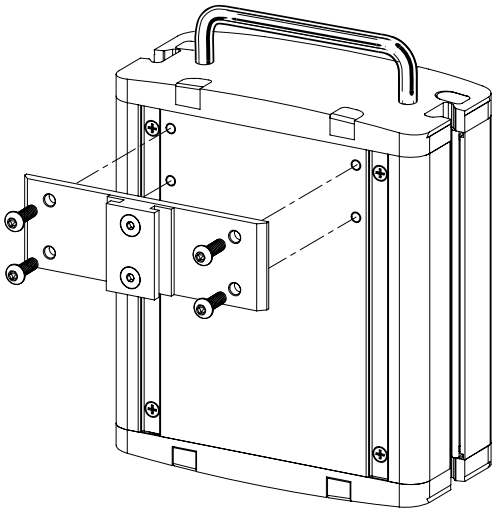

Product Code	Description
RD050-01	Neopuff™ Central Mounting Block Includes: 1 mounting tongue 1 mounting bar 2 M6 x 16 countersunk screws 4 M6 button head screws

Product Code	Description
900MR170	C-Clamp
900MR030	Pole Bracket
900MR088	Rail Bracket

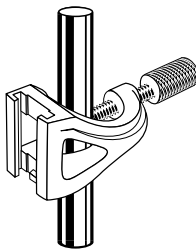

C-Clamp

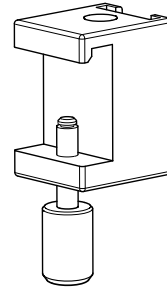

Rail Bracket

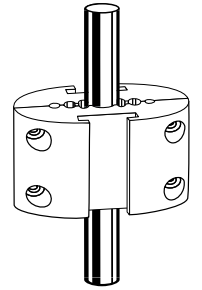

Pole Bracket

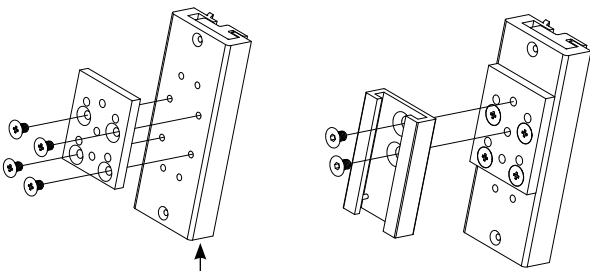

GE Mounting Bracket

## Ohmeda Assembly Kit

The Ohmeda Bracket is used to connect a F&P Neopuff™ Infant T-Piece Resuscitator easily to a GE Warmer or Incubator.

The Ohmeda/GE Mounting Bracket (0217-5363-800) is not supplied by Fisher & Paykel Healthcare and should be sourced from GE Healthcare.

Product Code	Description
BC513-01	Neopuff™-Ohmeda Assembly Kit

Bird MBlender  
2 to 16LPM  
BC501-01 (DISS)  
BC502-01 (NIST)  
  
NOTE:  
Gas Hoses not included.

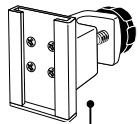

BC510-01  
Bird MicroBlender  
Pole Mount  
Bracket

900RD009  
Gas Supply Line

MR225  
Chamber  
or  
MR290  
Chamber

MR850  
Humidifier

900MR292  
Pole  
or  
900MR293  
Pole

Neopuff™  
Infant T-Piece  
Resuscitator  
(Stand Alone)  
  
NOTE:  
Refer to catalog for  
country code.

900MR030  
Mounting Bracket  
Pole  
15 to 50 mm

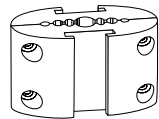

900IW305  
Accessory Hook

900RD110  
Single Use  
T-Piece Circuit  
- Humidified



900MR806  
Heater Heater-wire  
MR850  
  
900MR868  
Probe Temp/Flow  
Ang 1.1 m

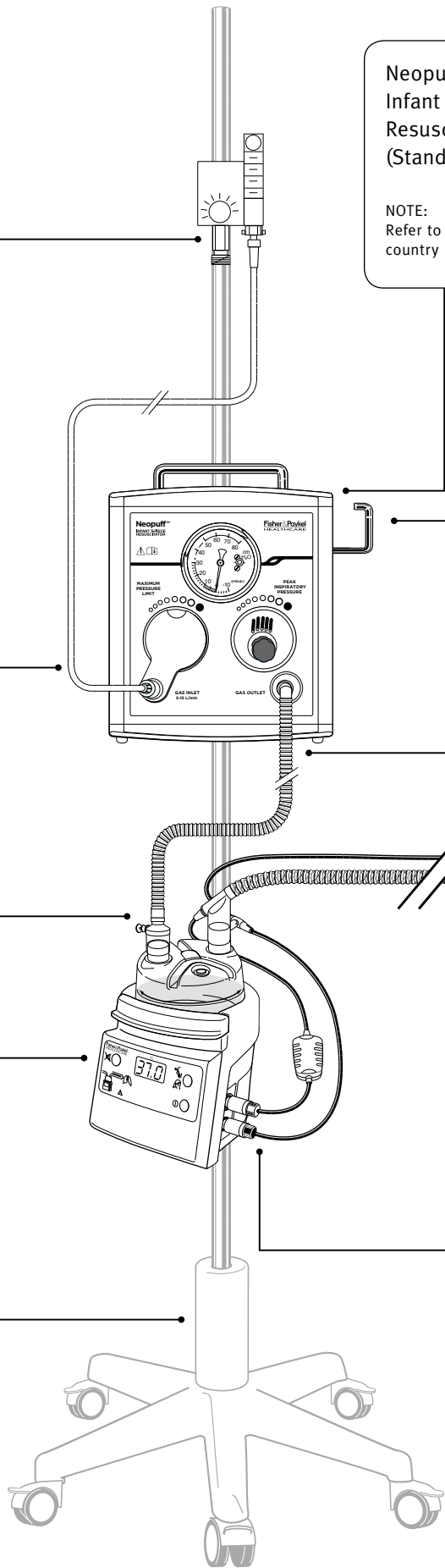

# PART NUMBER INDEX

Part Number	Page	Part Number	Page
<b>F&amp;P Neopuff™ Infant T-Piece Resuscitators</b>		HS-10UO-DFBMC4	12
RD900	2	HS-02IO-DHDFC4	12
900IW130	4	HS-10IO-DHDFC4	12
<b>F&amp;P Neopuff™ Accessories</b>		HS-10IO-NFBMC4	12
900IW305	10	HS-02IO-NFBMC4	12
900MR030	14	HS-10IO-DFBMC4	12
900MR088	14	HS-02UA-DHDFC4	12
900MR170	14	HS-10UA-DHDFC4	12
900MR806	11	HS-10UA-DFOMC4	12
900MR292	10	HS-10UA-DFPMC4	12
900MR293	10	HS-10UA-DFCMC4	12
900MR868	11	HS-10UA-DFSMC4	12
900RD008	10	HS-02IA-DHDFC4	12
900RD009	10	HS-10IA-DHDFC4	12
900RD010	6	HS-10IA-NFBMC4	12
900RD014-10	7	HS-02IA-NFBMC4	12
900RD015-10	7	HS-10-IA-DFBMC4	12
900RD016-10	7	MR225	11
900RD101	10	MR290	11
900RD110	6	MR850	11
900RD301	14	RD020-01	10
900RD302	14	RD050-01	15
043041042	12	RD800-EN	7
043041043	12	RD800-SK	7
043041044	12	RD803-10	7
043041045	12	RD804-10	7
043042374	12	RD805-10	7
043042375	12	RD806-10	7
BC501-01	11	RD807-10	7
BC502-01	11	RD1300-10	6
BC506-01	11	RD1301-10	6
BC507-01	11	RD1330-10	8
BC510-01	11	RD1340-10	8
BC513-01	15	RD1350-10	8
HS-02UO-DHDFC4	12	RD1360-10	8
HS-10UO-DHDFC4	12	RD1370-10	8
HS-10UO-DFOMC4	12	RD1331-10	9
HS-10UO-DFPMC4	12	RD1341-10	9
HS-10UO-DFCMC4	12	RD1351-10	9
		RD1361-10	9
		RD1371-10	9

## For more information please contact your local Fisher & Paykel Healthcare representative

### Manufacturer

Fisher & Paykel Healthcare Ltd  
15 Maurice Paykel Place  
East Tamaki, Auckland 2013

PO Box 14 348 Panmure  
Auckland 1741  
New Zealand

Tel: +64 9 574 0100  
Fax: +64 9 574 0158  
Email: [info@fphcare.com](mailto:info@fphcare.com)  
Web: [www.fphcare.com](http://www.fphcare.com)

### Australia

Tel: +61 3 9879 5022  
Fax: +61 3 9879 5232

### Austria

Tel: 0800 29 31 23  
Fax: 0800 29 31 22

### Benelux

Tel: +31 40 216 3555  
Fax: +31 40 216 3554

### China

Tel: +86 20 3205 3486  
Fax: +86 20 3205 2132

### France

Tel: +33 1 6446 5201  
Fax: +33 1 6446 5221

### Germany

Tel: +49 7181 98599 0  
Fax: +49 7181 98599 66

### India

Tel: +91 80 4284 4000  
Fax: +91 80 4123 6044

### Irish Republic

Tel: 1800 409 011

### Italy

Tel: +39 06 7839 2939  
Fax: +39 06 7814 7709

### Japan

Tel: +81 3 3661 7205  
Fax: +81 3 3661 7206

### Northern Ireland

Tel: 0800 132 189

### Spain

Tel: +34 902 013 346  
Fax: +34 902 013 379

### Sweden

Tel: +46 8 564 76 680  
Fax: +46 8 36 63 10

### Switzerland

Tel: 0800 83 47 63  
Fax: 0800 83 47 54

### Taiwan

Tel: +886 2 8751 1739  
Fax: +886 2 8751 5625

### Turkey

Tel: +90 312 354 34 12  
Fax: +90 312 354 31 01

### UK (EU Authorised Representative)

Fisher & Paykel Healthcare Ltd  
Unit 16, Cordwallis Park  
Clivemont Road, Maidenhead  
Berkshire SL6 7BU, UK

Tel: +44 1628 626 136  
Fax: +44 1628 626 146

### USA

Tel: +1 800 446 3908  
or +1 949 453 4000  
Fax: +1 949 453 4001